

SM82-EZ-II

Surface-Mount Speaker

Technical Information for System Engineers



SOUNDTUBE
ENTERTAINMENT

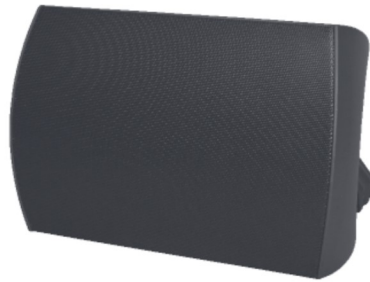

Specifications: SM82-EZ-II

Mounting hardware included

System Type	8-inch coax, surface-mount, ported (64-watt transformer for 25/70.7/100-volt or transformer bypass applications)	
Impedance (nominal) ¹	8 ohms	
Sensitivity dB @ 2.83 V/1 m	87.0 dB	
Sensitivity dB @ 1 W/1 m ²	87.0 dB	
Frequency Response (-3 dB) ³	50 Hz - 20 kHz	
Frequency Response (-10 dB) ³	38 Hz - 22 kHz	
Max. Program Power ⁴	150 W	
Max. Continuous Power RMS ⁵	75 W	
Max. Power SPL @ 1 m ⁶	106.0 dB	
Coverage Angle (-6 dB @ 2 kHz)	70° Horizontal / 90° Vertical	
Coverage Angle (-6 dB @ 10 kHz)	110° Horizontal / 100° vertical	
Coverage Angle (averaged 2-10 kHz)	90° horizontal / 105° vertical	
Aiming Angle	0°-90°	
Directivity Factor (Q)	5.20 (Averaged 100 Hz - 10 kHz); 12.0 @ 2 kHz	
Directivity Index (DI)	6.20 (Averaged 100 Hz - 10 kHz); 10.8 @ 2 kHz	
Tap Selector	Six-position rotary switch with transformer bypass	
Transducer - Low-Frequency Driver	203.0 mm (8.0 in.) polypropylene woofer with butyl rubber surround	
Transducer - High-Frequency Driver	25.0 mm (1.0 in.) soft dome tweeter	
Low-Frequency Voice Coil	38.1 mm (1.50 in) high temperature Kapton	
Crossover Frequency	2.5 kHz	
Network Type - Low Pass	12 dB per octave, 2nd order	
Network Type - High Pass	12 dB per octave, 2nd order	
Enclosure Material	High Impact Poly Styrene (HIPS)	
Grille	Aluminum with powder-coat finish	
Inputs	4 position ceramic terminal strip	
Colors	Black or white	
Height	457.2 mm (18.00 in.)	
Width	292.1 mm (11.50 in.)	
Depth	251.4 mm (9.9 in.)	
Weight	7.1 kg (15.4 lbs.)	
Shipping Weight	7.4 kg (16.2 lbs.)	
Included Accessories	Safety cable, wall mount bracket, port plug, allen wrench and watertight strain-relief bushing	
Packaging	One per box	
Regulatory - CE	Approved	
Regulatory - UL	UL 1480A planned	
EN54-24	Planned	
RoHS	Approved	
IP65 (sealed version)	Approved	

Transformer Taps

	70.7 V	Output	100 V	Output	25 V	Output
1	64 W	105.0 dB	64 W	105.0 dB	8 W	96.0 dB
2	32 W	102.0 dB	32 W	102.0 dB	4 W	93.0 dB
	16 W	99.0 dB	16 W	99.0 dB	2 W	90.0 dB
3	8 W	96.0 dB	8 W	96.0 dB	1 W	87.0 dB
	4 W	93.0 dB				

1 Impedance listed per IEC 60268-5 with a minimum less than 80% the nominal impedance

2 1 W/1 m sensitivity determined using nominal impedance

3 Frequency response measured in half or full space as dictated by speaker mounting configuration

4 Max program power is 3 dB above max continuous power

5 Continuous power rating, EIA-426-B test

6 Max output based on max continuous power

Key Features

- The SM82-EZ-II is a cost-conscious, weather-resistant, surface-mount loudspeaker.
- BroadBeam Ring™ technology for midrange clarity and ultra wide off axis performance up to 10 kHz for maximum coverage area per speaker.
- One 8.00 inch (203 mm) polypropylene woofer and one 1.0 inch (25.4 mm) soft dome tweeter.
- IP65 rated (when included port plug is installed) for high dust- and water-resistance.
- 87.0 dB average sensitivity offers high output capabilities and reduced amplification costs.
- Easy access, six-position selectable tap switch for 25-, 70.7- and 100-volt applications with transformer bypass position.
- Aluminum grille with powder-coat finish.
- Vertical and horizontal mounting offer precision aiming for indoor and outdoor applications.
- UL 1480 (UEAY) and EN54-24 planned.
- High-quality black or white paint finish.
- Included Accessories: Safety cable, wall mount bracket, port plug, allen wrench and watertight strain-relief bushing.

Description

The SM82-EZ-II is a cost-effective, high-efficiency surface-mount loudspeaker for distributed or 8 ohm applications. The SM82-EZ-II incorporates a dedicated 8-inch polypropylene woofer and an offset 1-inch soft dome tweeter with waveguide to deliver superb intelligibility for background to foreground music and messaging (up to 106.0 dB max. SPL).

The SM82-EZ-II uses a 64-watt low-insertion loss transformer and a six-position tap switch with a transformer bypass position. Mounting for the SM82-EZ-II includes a pre-mountable U-bracket for fast, secure installation and easy division of labor.



Applications

Engineered for cost-conscious applications requiring true intelligibility, quality low-frequency response and quick installation, the versatile SM82-EZ-II delivers smooth and even coverage ideal for casinos, convention centers, gyms, nightclubs, aerobic rooms, airports, super stores, arenas, theme parks, transportation hubs, shipping centers and stadiums. For additional low-end response down to 41 Hz (-10 dB) the powered SM1001p may be incorporated.

Patented SoundTube Technologies

SoundTube Entertainment and MSE Audio Group constantly develop new technologies that enhance audio product performance. SoundTube Entertainment innovations are protected by multiple U.S. and international patents, which explicitly cover SoundTube dispersion, enclosure and dome technologies. MSE Audio Group actively defends its patents in order to protect SoundTube resellers and end users.

Technical Data and Specification Tools

Technical Data

SoundTube Entertainment strives to provide complete and effective technical information and data to dealers, engineers and designers. All data are available from SoundTube Entertainment or at www.soundtube.com.

Technical data and downloads include:
EASE™ data – 3-D polar plots.

EASE™ Address – 2-D modeling for distributed systems

Autodesk® Revit® software

Tech Sheets – Technical information and architectural specs for system engineers

SoundTubeSPEC™ – Proprietary speaker placement software

Independent Data Acquisition and Verification

All data for SoundTube speakers is independently collected and verified by a third party. All data is collected and analysed according to ASTM, ISO and AES standards using EASERA, TEF and

MLSSA. Full balloon data including both phase and magnitude is compiled into a variety of for

Architectural Specifications

The loudspeaker shall consist of one 203.0 mm (8.0 in.) polypropylene low-frequency transducer with butyl rubber surround and one 25.4 mm (1.0 in.) soft dome high-frequency transducer. The system shall include a crossover network and 64-watt transformer installed in the enclosure. The low-frequency voice coil diameter shall be 38.1 mm (1.50 in.).

Performance specifications for a typical production unit shall be as follows: useable frequency response shall extend from 38 Hz-22 kHz (-10 dB, half space, independently verified). Measured sensitivity (2.83 volt, 1 meter) shall be at least 87.0 dB. The speaker shall have a nominal impedance of 8 ohms. The speaker shall be available for 25-, 70.- and 100-volt modes and shall include a six-position tap switch with a transformer bypass position. The frequency-dividing network shall have a crossover frequency of 2.5 kHz with slopes of 12 dB per octave (2nd order) for both low- and high-pass filters. Rated power capacity shall be at least 64 watts continuous (RMS) and conform to EIA-426 testing. Maximum continuous output at 1 meter shall be 106.0 dB.

The low frequency transducer shall have a polypropylene cone with butyl rubber surround. The high frequency transformer shall be constructed of silk material with a proprietary BroadBeam Ring™ waveguide.

Installation and safety attachment for the speaker shall be by U-bracket affixed to the speaker chassis with steel insert. For safety redundancy, a secondary cable shall be included and attached to the speaker chassis.

The enclosure shall be constructed of injection-molded, High Impact Poly Styrene (HIPS). The grille shall be constructed of powder-coated aluminium for lasting performance. Overall dimensions including the mounting plate and bracket for the speaker are 457.2 mm (18.00 in.) tall by 292.1 mm (11.50 in.) wide by 251.4 mm (9.9 in.) deep. The unit shall include port plug, allen wrench and watertight strain-relief bushing.

The system shall be the SM82-EZ-II for both low- and high-impedance applications.

SoundTube Entertainment

13720 W. 109th St.
Lenexa, KS 66215
Phone 913.663.5600
Fax 435.647.9666
Toll Free 800.647.TUBE
www.soundtube.com

All SoundTube products come with a 5-year limited warranty.

Graphs and Plots

Frequency Response

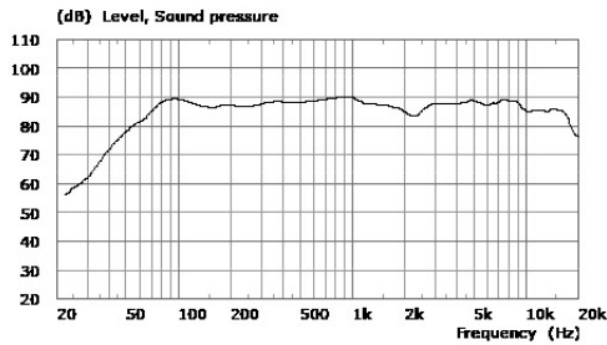

Impedance/Phase

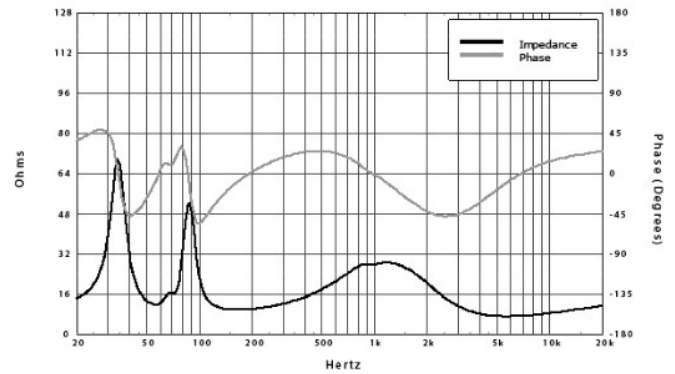

Vertical Beamwidth

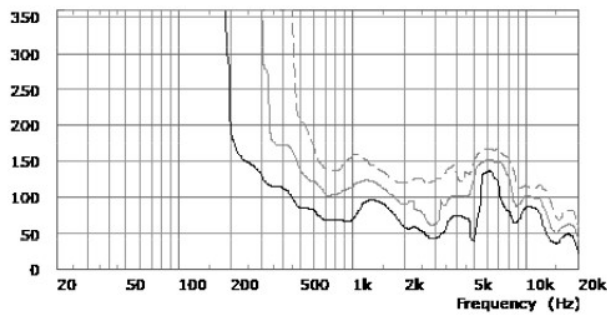

Directivity Index (DI)

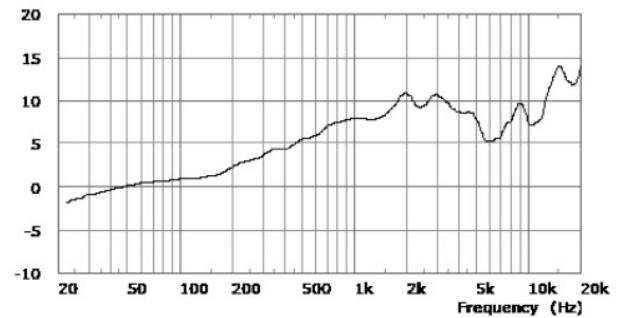

SM82-EZ-II

Surface-Mount Speaker
Technical Information for System Engineers



SOUNDTUBE
ENTERTAINMENT

Polar Plots

———— Horizontal
- - - - - Vertical

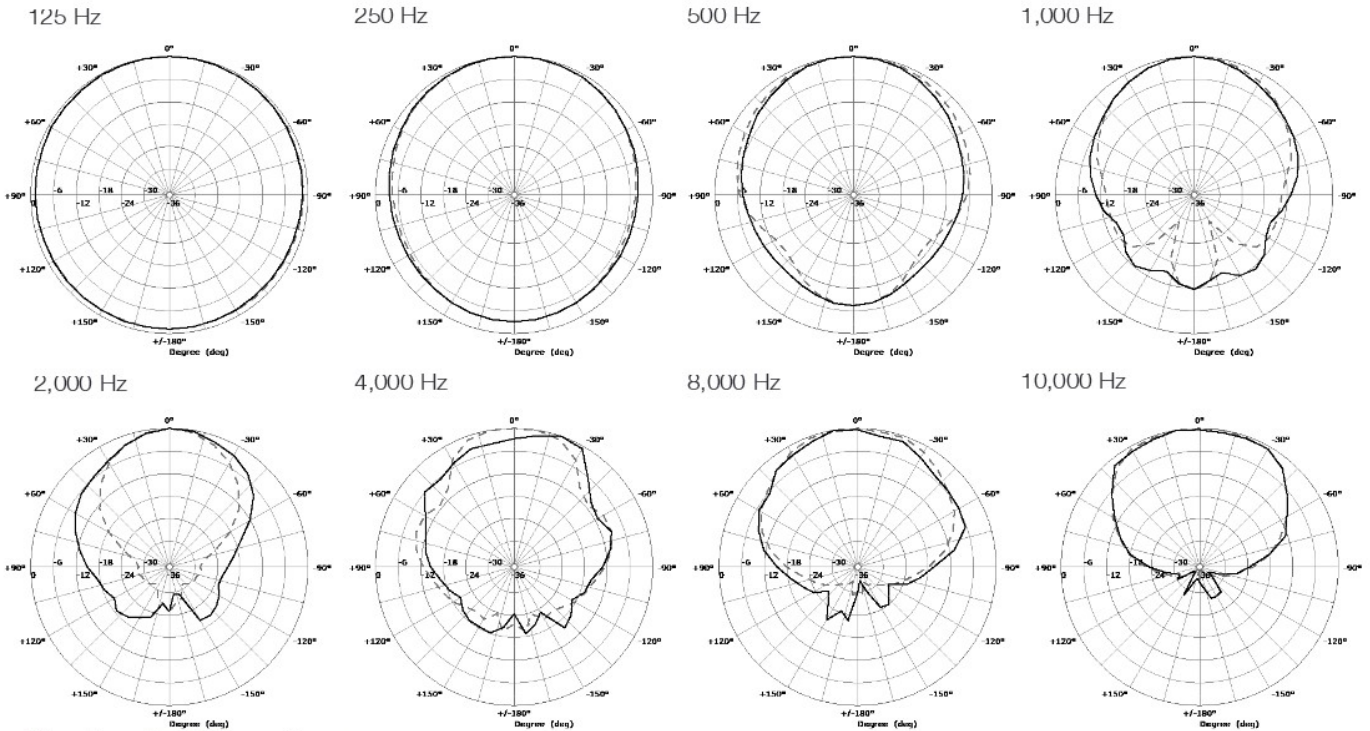

Mechanical Drawings

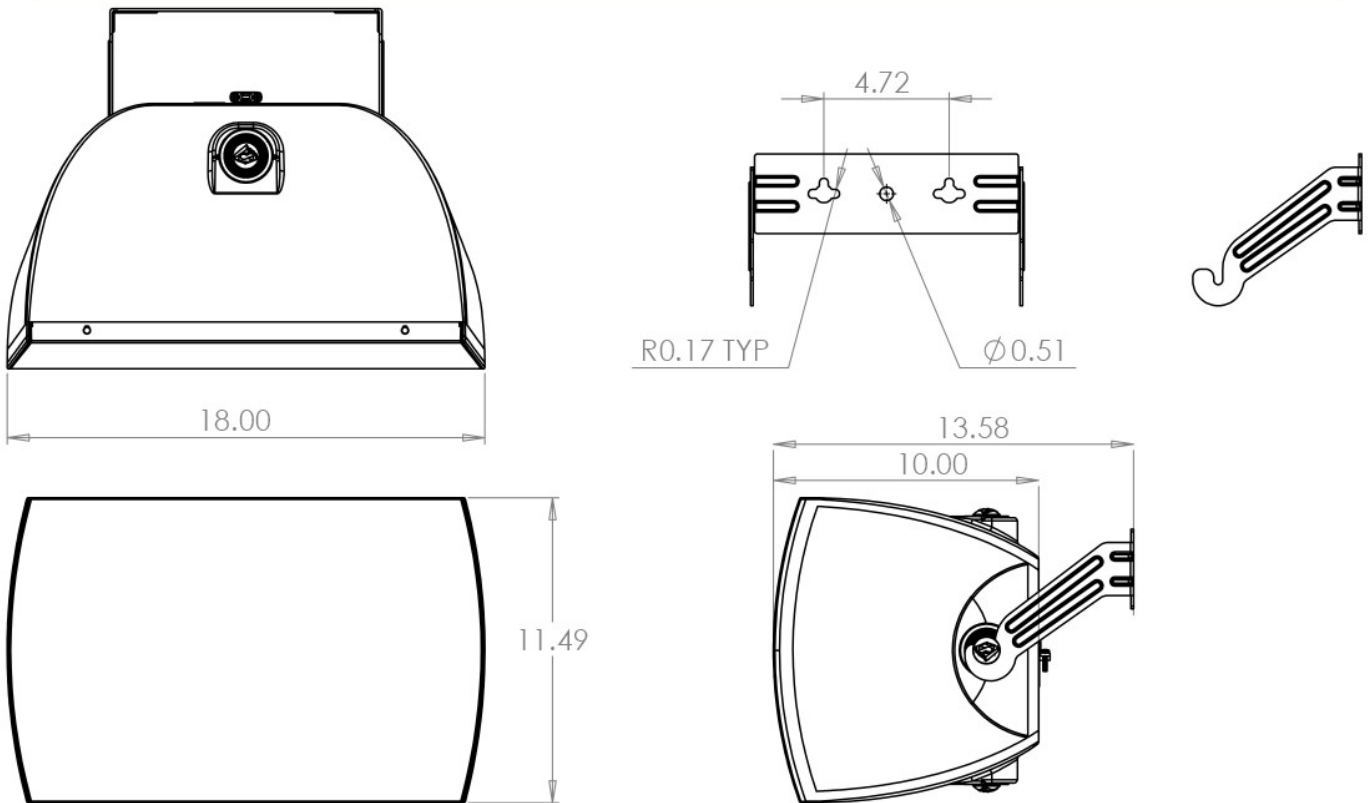

SoundTube Entertainment manufactures a complete line of speakers for:
Open-Ceiling • In-Ceiling • Surface-Mount • Outdoor • Sound-Focusing
 All SoundTube products are designed and engineered in the USA.