

DATASHEET

# PAN SPEAKER P 12-CX - PASSIVE COAXIAL LOUDSPEAKER

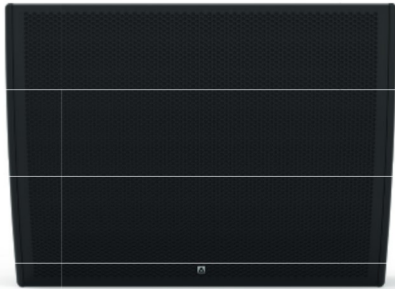

The **Pan Speaker P 12-CX** is a passive 2-way coaxial speaker with ported design for immersive sound and high quality music applications. The **Pan Speaker P 12-CX** is characterized by a precise and natural sound reproduction over the frequency range from 48 - 22,000 Hz.

The speaker uses a coaxial chassis with an 12" woofer and a 2.85" tweeter unit with compression driver. The cabinet is made of sustainable wood material and can be painted in any color according to the customer's requirements. The chassis is protected from external influences by a sturdy perforated front grille.

The cabinet of the loudspeaker is designed in such a way that the vertical dispersion axis of the loudspeaker is tilted by 15° when mounted on a wall.

At the rear of the **P 12-CX** a connection plate with a 4-pin connector panel is recessed into the housing. Also on the connection plate is a thread to accommodate an M10 eyebolt for fall protection. Optionally, the **P 12-CX** is also available with Speakon NL4 connection. On the rear and side surfaces are various mounting points designed for attaching accessories such as an adapter plate for tilting wall mounts, ceiling mounts, U-brackets or rigid wall mounts.

It is possible to operate the **P 12-CX** either individually or in combination with the P SW-112 or P SW-118 from the Pan Subwoofer series.

## EQUIPMENT / OPTIONS



See last page for explanation of the symbols.

## APPLICATIONS

Immersive Sound, Variable Room Acoustics (ACS), Museums, Conference Rooms, Lecture Halls, Audio/Video Presentation Rooms

## FEATURES

High efficiency, integrated protection circuitry, high quality over a wide frequency range, symmetrical radiation characteristics, compact, inconspicuous design.

## MOUNTING ACCESSORIES

For the **Pan Speaker** series, there is a wide range of mounting accessories for fixed installation and mobile use.

All **Pan Speaker** loudspeakers are designed, developed and manufactured in Germany by Pan Acoustics according to strict criteria and with high-quality materials.



## TECHNICAL DATA PAN SPEAKER P 12-CX

### ACOUSTIC PROPERTIES

<b>Configuration:</b>	passive, compact coaxial loudspeaker
<b>Frequency range:</b>	48 Hz - 22 kHz
<b>Equipment:</b>	1 x 12"/2,85" Coax
<b>Rated power:</b>	1200 W (peak <sub>20ms</sub> )/ 600 W (programme)/ 300 W (nominal)
<b>Recommended amplifier:</b>	DSP power amplifier
<b>Sensitivity:</b>	94 dB 1W/1m
<b>Maximum SPL:</b>	131 dB* (peak) @1m
<b>Impedance:</b>	8 Ohm
<b>Radiation pattern h/v:</b>	90° radial
<b>Connections I/O:</b>	1 x 4-pole screw connection terminal for connection cable with 4 mm <sup>2</sup> Ø
<b>Operating temperature:</b>	-10 °C to +50 °C (ambient temperature)

### MECHANICAL PROPERTIES

<b>Enclosure:</b>	Wood
<b>Grille:</b>	Powder coated perforated sheet metal with textile cover
<b>Standard colors:</b>	RAL 9005 (black), silk matt RAL 9010 (white), silk matt
<b>Dimensions (HxBxT):</b>	457 x 615 x 351 [mm]
<b>Weight:</b>	25 kg
<b>Mounting options:</b>	Other mounting accessories available.

\*Under anechoic half-space conditions with DSP settings.  
Frequency range: -10 dB under anechoic half-space conditions.





## TECHNICAL DATA PAN SPEAKER P 12-CX | NL4

### ACOUSTIC PROPERTIES

<b>Configuration:</b>	passive, compact coaxial loudspeaker
<b>Frequency range:</b>	48 Hz - 22 kHz
<b>Equipment:</b>	1 x 12"/2,85" Coax
<b>Rated power:</b>	1200 W (peak <sub>20ms</sub> )/ 600 W (programme)/ 300 W (nominal)
<b>Recommended amplifier:</b>	DSP power amplifier
<b>Sensitivity:</b>	94 dB 1W/1m
<b>Maximum SPL:</b>	131 dB* (peak) @1m
<b>Impedance:</b>	8 Ohm
<b>Radiation pattern h/v:</b>	90° radial
<b>Connections I/O:</b>	1 x Speakon NL4 (1+/1-)
<b>Operating temperature:</b>	-10 °C to +50 °C (ambient temperature)

### MECHANICAL PROPERTIES

<b>Enclosure:</b>	Wood
<b>Grille:</b>	Powder coated perforated sheet metal with textile cover
<b>Standard colors:</b>	RAL 9005 (black), silk matt RAL 9010 (white), silk matt
<b>Dimensions (HxBxT):</b>	457 x 615 x 351 [mm]
<b>Weight:</b>	25 kg
<b>Mounting options:</b>	Other mounting accessories available.

\*Under anechoic half-space conditions with DSP settings.  
Frequency range: -10 dB under anechoic half-space conditions.



TECHNICAL DRAWING PAN SPEAKER P 12-CX

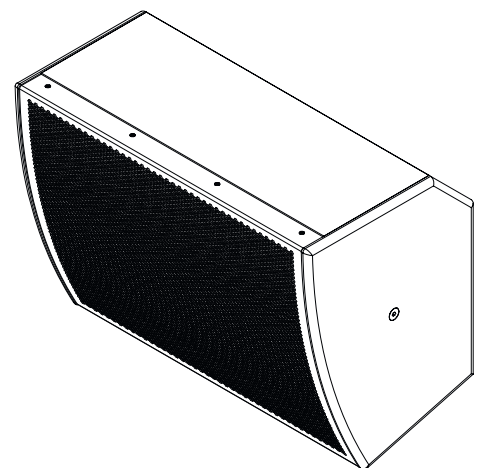
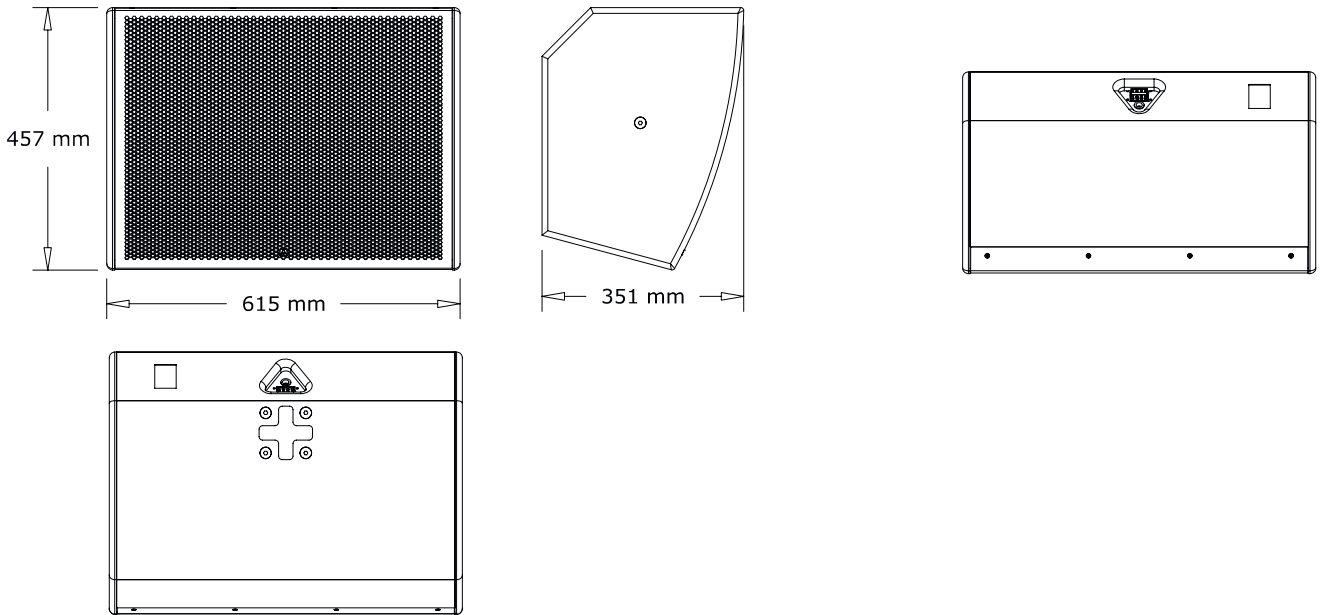

TECHNICAL DRAWING PAN SPEAKER P 12-CX | NL4

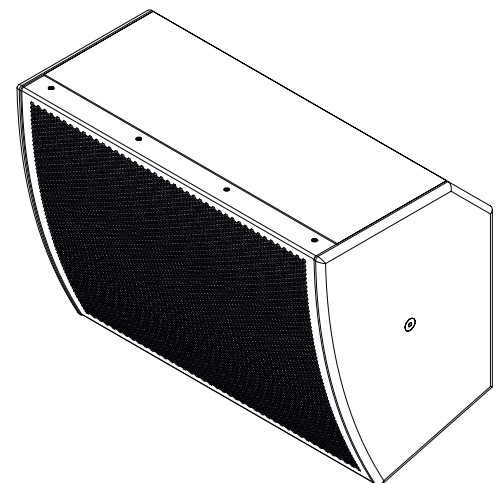
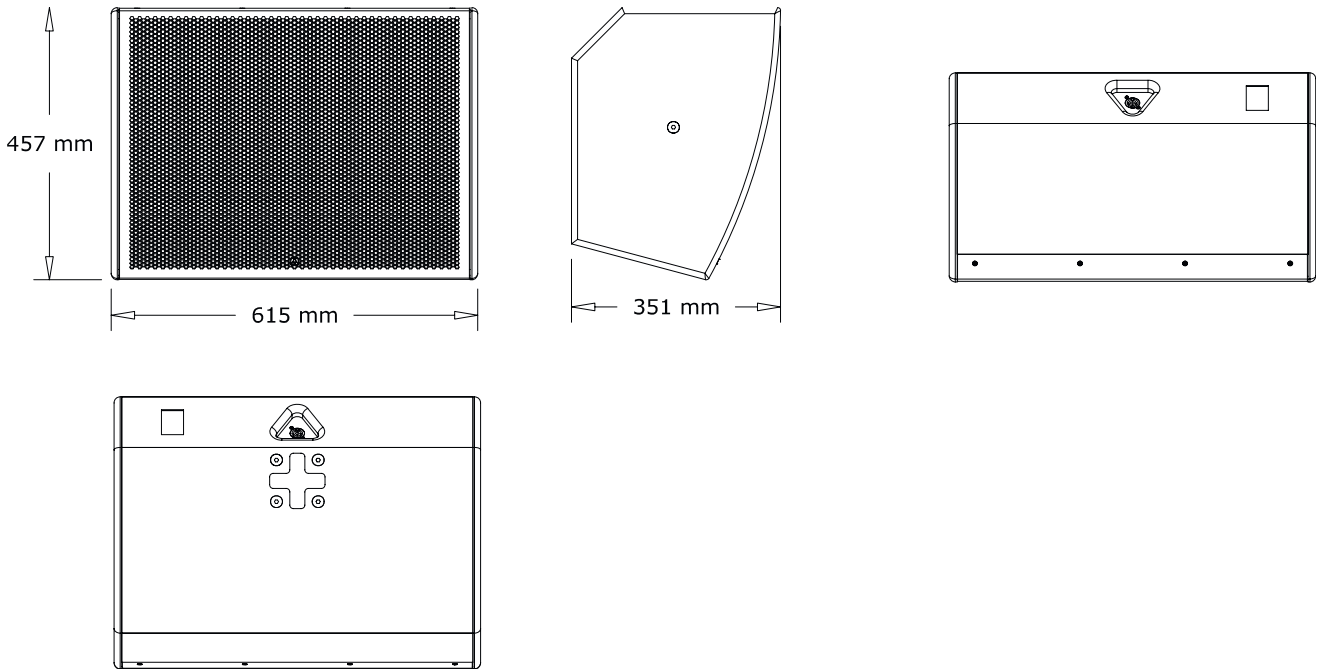

**EQUIPMENT / OPTIONS AT GLANCE – PAN SPEAKER SERIES**



**Customised painting/coloring**  
within the RAL color range. Other color systems such as RAL design, Pantone, etc. are available on request.

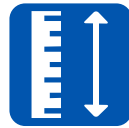

**Made-to-measure enclosure**  
The enclosure dimensions of the Pan Speaker series can be customised.



**100 V audio inputs** with selectable power taps.



**Accessories** such as wall, tripod and ceiling mounts, different interfaces, connection cables, weather protection hoods and connection sets are available.



**Weatherproofing** of the loudspeakers in accordance with protection classes IP54 or IP65 (depending on the model) is possible.



**Ball impact resistance**



**Looks good, sounds good.**  
Pan Acoustics' products are defined by natural sound and attractive design.

Some equipment features cannot be combined. For information about which features can be combined with each other, please send an e-mail to [sales@pan-acoustics.de](mailto:sales@pan-acoustics.de).

### Our quality promise

**Pan Acoustics** stands by its products and gives up to **10 years warranty** on its loudspeakers for any material or manufacturing defects. New products manufactured in accordance with protection classes IP54 and IP65 as well as digital audio interfaces (Dante®) from Audinate Pty Ltd and rechargeable batteries are excluded from the 10-year warranty. A warranty period of 3 years is granted for loudspeakers in accordance with protection classes IP54 and IP65.

